

Article number: 437900024

Description: Rota-fix shaft-hub connection SA 24

Measures

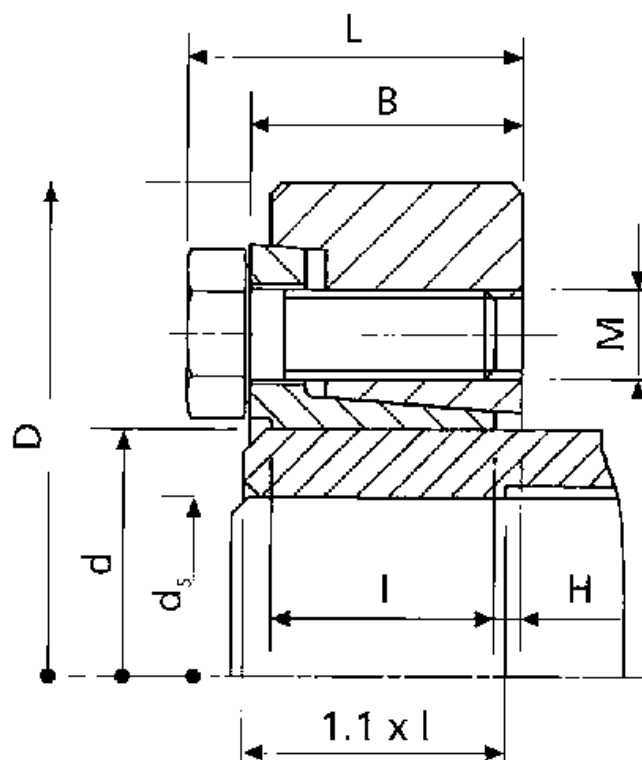

B mm	= 18.0	M mm	= M6
d H8 mm	= 24	T N m torque	= 165
D mm	= 50.0	Ts N m bolt tightening torque	= 13
ds mm	= 19		
F kN torque	= 17		
H	= 2.0		
I mm	= 15.0		
L mm	= 22.0		